



2009/2010 General Catalog

TTI makes difference

Brings world together



tti

CONTENTS

| | |
|------------------------------|--|
| CB TRANSCEIVERS | 04_ TCB-550 |
| | 05_ TCB-660 |
| | 06_ TCB-771 |
| | 07_ TCB-881 |
| | 08_ TCB-775 |
| | 09_ TCB-880H |
| | 10_ TCB-1100 |
| | 11_ TX-410 |
| CB ACCESSORIES | 12_ Hands free THF-100/THF-100P |
| | 13_ CB Antennas |
| | 14_ External Speakers |
| | 15_ DCDC-Converters |
| | 16_ D i n - P l a t e s |
| CB FEATURE TABLE | 17_ CB Feature Table |
| PMR 446 RADIOS | 18_ PMR-121TX |
| | 19_ PMR-506TX |
| | 20_ TX L - 4 4 6 |
| | 21_ TX-1446P |
| LPD RADIOS | 22_ WP1/WP1 TRIO |
| | 23_ LPD-200 |
| | 24_ LPD-400 |
| | 25_ LPD-500 |
| RECEIVERS | 26_ TSC-3000R |
| | 27_ TSC-100R |
| MARINE RADIO | 28_ TX-150M |
| PMR/LPD FEATURE TABLE | 30_ PMR/LPD Features |
| PMR/LPD ACCESSORIES | 32_ Accessories |

TTI MULTI BAND CB-RADIO SERIES

The new Citizen Band(CB) Radio from TTI set remarkable new standards in the industry with its SMT and the most updated technology in terms of design, features and performances.

Slim & Compact Auto Squelch Imbedded

Smallest sized, TCB-550 is equipped with the state-of-the-art technology of Auto Squelch, which works perfectly in the FM mode. A simple clicking of the squelch control will always lead you to the manual squelch mode.



TCB-550, specially, is designed with compact and slim concept, but still with powerful features including Multi-Band capabilities. Easy operation and space saving are another big advantages.

The combination of conventional black housing and big LCD with the blue illumination encompasses a wide range of advanced technology.

TCB-550

TCB-550 Features

- Multiple Bands
- 4 Watts Output Power
- AM/FM Operation
- Menu Mode
(Beep Tone On/ Off,TOT,Backlight Dimmer)
- Emergency Channel (9/19)
- Scan
- Keypad Lock
- Squelch Control (Auto / Manual)
- Blue Illumination
- Dimension (W x H x L) : 124 x 37 x 135mm

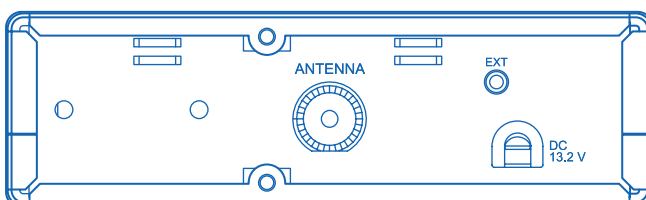
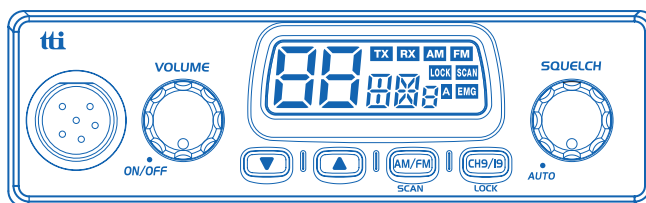

TTI MULTI BAND CB-RADIO SERIES

The new Citizen Band (CB) Radio from TTI set remarkable new standards in the industry with its SMT and the most updated technology in terms of design, features and performances.

DIN Size & Full Features

As it is DIN sized, TCB-660 is quite easily accepted to any locations like car audio compartment or anywhere in your car. The control keys of the microphone enhances your handiness controlling the transceiver.



TCB-660, like other TTI CB radios, has powerful full-features including Multi-Band and full 4W output power. But, still compact and simple design with easy operation keys and buttons. Whether you are using the TCB-660 in a truck, car, or at home, you will appreciate the ease of operation and excellent quality of communications.

Heavy-duty Microphone is including a long curl cord for easy operations. You may also choose handy, light-weight Microphone as an option.

TCB-660

TCB-660 Features

- Multiple Bands
- 4 Watts Output Power
- AM/FM Operation
- Menu Mode
(Beep Tone On/ Off, TOT, Backlight Dimmer)
- Emergency Channel (9/19)
- Last Channel Recall
- Scan
- Keypad Lock
- Remote Channel Up/Down
- Squelch Control
- External Speaker Connection Jack
- Blue Illumination
- Dimension (W x H x L) : 140 x 37 x 186mm

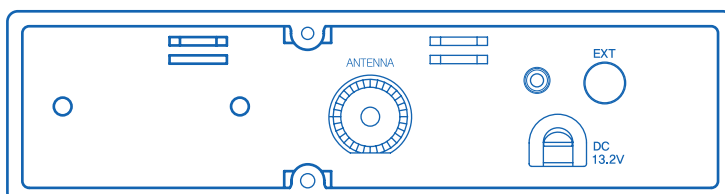
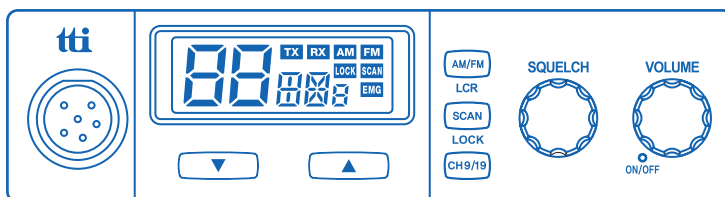

TTI MULTI BAND CB-RADIO SERIES

The new Citizen Band (CB) Radio from TTI set remarkable new standards in the industry with its SMT and the most updated technology in terms of design, features and performances.

Dynamic Squelch System ! Deluxe & Dual Voltage

As a sister unit of TCB-770, TCB-771 responds to the customer requirement for free connection to any power sources of vehicles this transceiver is used in.



TCB-771, along with Dual Voltage capability, will become a new market leader in the industry. TCB-771 has all the features and advantages of TCB-770 as well. Whether you are using the TCB-771 in a truck, car or at home, you will appreciate the ease of operation and excellent quality of communications.

TCB-771

● TCB-771 Features

- 12/24 Volt Input
- Multiple Bands
- 4 Watts Output Power
- AM/FM Operation
- Menu Mode
(Beep Tone On/Off, TOT, Backlight Dimmer)
- Emergency Channel (9/19)
- Scan
- Keypad Lock
- Remote Channel Up/Down
- External Speaker Connection Jack
- External S-Meter Connection Jack
- Quick Channel Up/Down
- Squelch Control
- DSS (Dynamic Squelch System)
- Blue Illumination
- Dimension (W x H x L) : 140 x 37 x 186mm

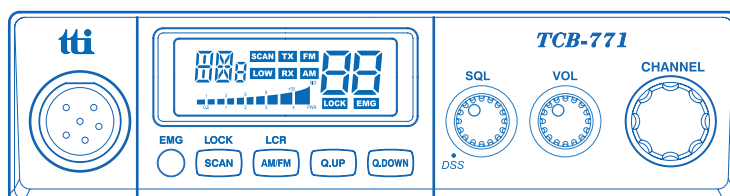
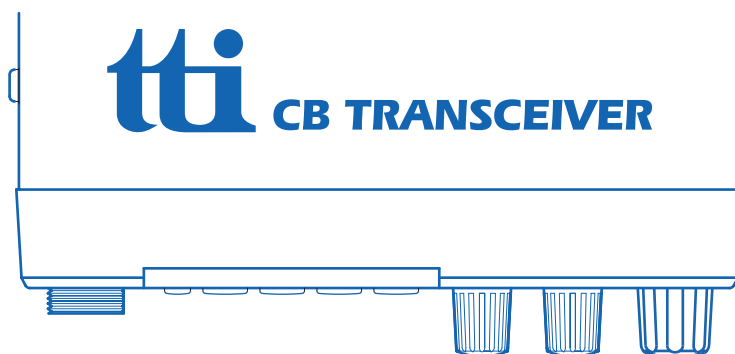

TTI MULTI BAND CB-RADIO SERIES

The new Citizen Band(CB) Radio from TTI set remarkable new standards in the industry with its SMT and the most updated technology in terms of design, features and performances.

TTI
2009

Dynamic Squelch System! Professional & Dual Voltage

As a sister unit of TCB-880, TCB-881 responds to the customer requirement for free connection to any power sources of vehicles this transceiver is used in.



TCB-881

TCB-881, along with Dual Voltage capability, will become a new market leader in the industry.

TCB-881 has all the features and advantages of TCB-880 as well. Whether you are using the TCB-881 in a truck, car, or at home, you will appreciate the ease of operation and excellent quality of communications.

The combination of conventional black or silver housing and blue illumination encompasses a wide range of advanced technology.

• TCB-881 Features

- 12/24 Volt Input
- Multiple Bands
- 4 Watts Output Power
- AM/FM Operation
- Menu Mode
(Beep Tone On/Off, TOT, Backlight Dimmer)
- Emergency Channel(9/19)
- Scan
- Keypad Lock
- Remote Channel Up/Down
- External Speaker Connection Jack
- External S-Meter Connection Jack
- Quick Channel Up/Down
- CB/PA Selection
- Dual Watch
- ANL
- MIC Gain Control
- RF Gain Control
- Local/DX Selector
- 4 Memory Buttons
- Squelch Control
- DSS (Dynamic Squelch System)
- Blue Illumination
- Dimension (W x H x L) : 156 x 51 x 176mm

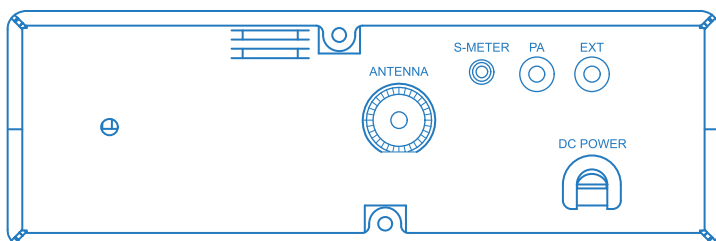
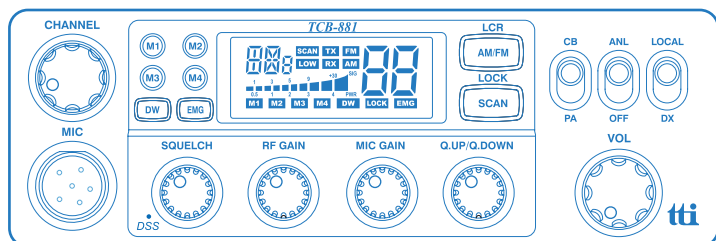

TTI MULTI BAND CB-RADIO SERIES

The new Citizen Band(CB) Radio from TTI set remarkable new standards in the industry with its SMT and the most updated technology in terms of design, features and performances.

Deluxe & 10 W

The TCB-775 is the CB Transceiver that you must choose if you are experiencing a difficulty communicating in a metropolitan area. This guarantees clear audio and microphone in a congested area surrounded by a lot of buildings and vehicles.



TCB-775 LIBERTA, in addition to all the excellent features and functions of TCB-770, has 10W output power. Longer communication range will be another satisfactory benefits for your easy-touch.

TCB-775

• TCB-775 Features

- Multiple Bands
- High Output Power (FM 10W)
- AM/FM Operation
- Menu Mode
(Beep Tone On/Off, TOT, Backlight Dimmer)
- Emergency Channel(9/19)
- Last Channel Recall
- Quick Channel Up&Down
- Scan
- Keypad Lock
- Remote Channel Up/Down
- External Speaker Connection Jack
- External S-Meter Connection Jack
- MIC Gain Control
- RF Gain Control
- Squelch Control
- Blue Illumination
- Dimension (W x H x L) : 140 x 37 x 186mm

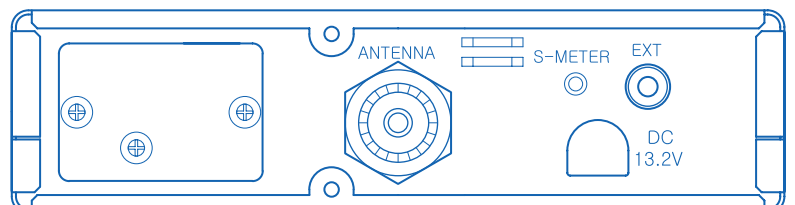
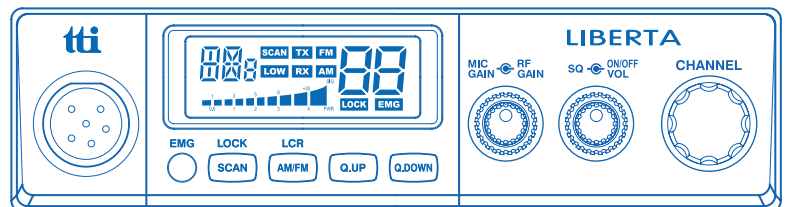

TTI MULTI BAND CB-RADIO SERIES

The new Citizen Band(CB) Radio from TTI set remarkable new standards in the industry with its SMT and the most updated technology in terms of design, features and performances.

TTI
2009

Professional & 25W

TCB-880H provides maximum in features and power. This results in guaranteeing clear communication wherever you are. Enjoy the best combination of power and features.



TCB-880H, in addition to all the excellent features and functions of TCB-880. has MAX Power of 25W. Longer communication range will be another satisfactory benefits for your easy-touch.

TCB-880H

• TCB-880H Features

- Multiple Bands
- High Output Power (FM 25W)
- AM/FM Operation
- Menu Mode
(Beep Tone On/Off, TOT, Backlight Dimmer)
- Emergency Channel(9/19)
- Scan
- Keypad Lock
- Remote Channel Up/Down
- External Speaker Connection Jack
- External S-Meter Connection Jack
- Quick Channel Up/Down
- CB/PA Selection
- Dual Watch
- ANL
- MIC Gain Control
- RF Gain Control
- Local/DX Selector
- 4 Memory Buttons
- Squech Control
- Blue Illumination
- Dimension (W x H x L) : 156 x 51 x 176mm

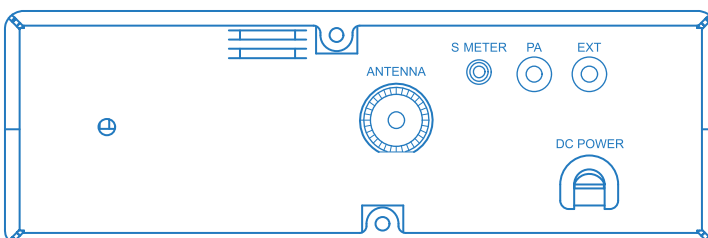
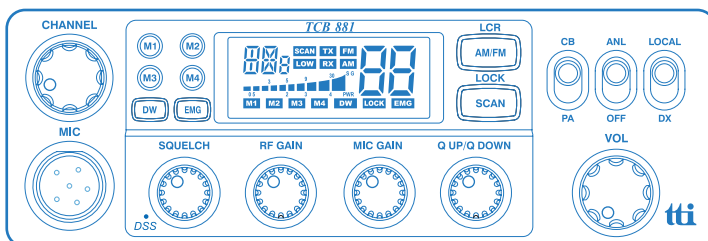

TTI MULTI BAND CB-RADIO SERIES

The new Citizen Band(CB) Radio from TTI set remarkable new standards in the industry with its SMT and the most updated technology in terms of design, features and performances.

10 W & Front Speaker with Tones Installed

Why should we endure the mumbled audio sound generated from the bottom sides of the conventional CB transceivers? The front installed speaker delivers you better and clearer audio sound. You could take your partners to where there is no traffic by a tone selection, which is amazing.



TCB-1100, TTI's flagship model, has new design concept with Front Speaker, Full DIN-Size, CTCSS, VOX, and many other amazing features. You can experience many operations that have never been tried in any CB radio before; Voice back-up channel selection, changeable backlighting color, tone selection, compander selection and etc.,

TCB-1100

TCB-1100 Features

- 4W or 10W Version
- Multiple Bands
- AM/FM Operation
- Menu Mode
(Beep Tone On/Off, TOT, Backlight Dimmer)
- Emergency Channel (9/19)
- Memory
- Last Channel Recall
- Scan & Scan Memory
- Remote Channel Up/Down
- External Speaker Connection
- External S-Meter Connection
- Channel Up & Down
- Quick Channel Up/Down
- MIC Gain Control
- RF Gain Control
- Dynamic Squelch System
- Dual Watch
- VOX
- Tone Selection
- Compander Circuit Selection
- Backlight Selection
- Selection of In-dash Mounting or Bracket Mounting
- Dimension (W x H x L) : 140 x 37 x 186mm

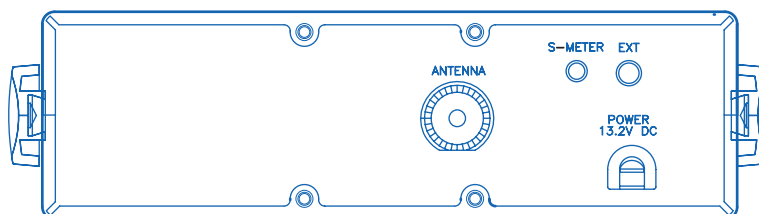
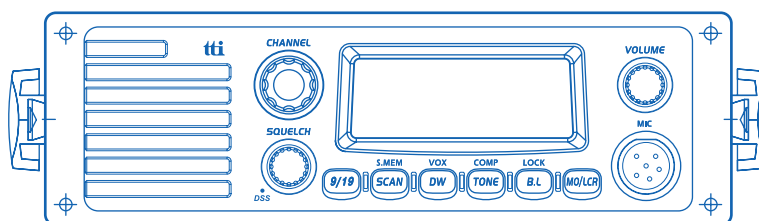

TTI VHF LOW BAND TRANSCEIVER

The new VHF Low-Band Transceiver Radio from TTI set remarkable new standards in the industry with its SMT and the most updated technology and quality performances.

20 Watts

This will be a real best buy for anybody who likes to be a practical investor. A good question will be emerged once this transceiver is tried, why more money should be paid for.



TX-410 is the ideal VHF Low-Band Mobile Radio for reliable communications in the vehicles by combining the key requirements of high-end users : reliability, durability, functionality and performance. no other compact VHF Low-Band Mobile Radio can deliver so much versatility and functionality with its affordable budget.

BACKLIGHTED FREQUENCY READ-OUTS WITH CHANNEL DISPLAY

Well sized and backlighted frequency Read-outs enhances the vision and helps finding where you are.

TX-410

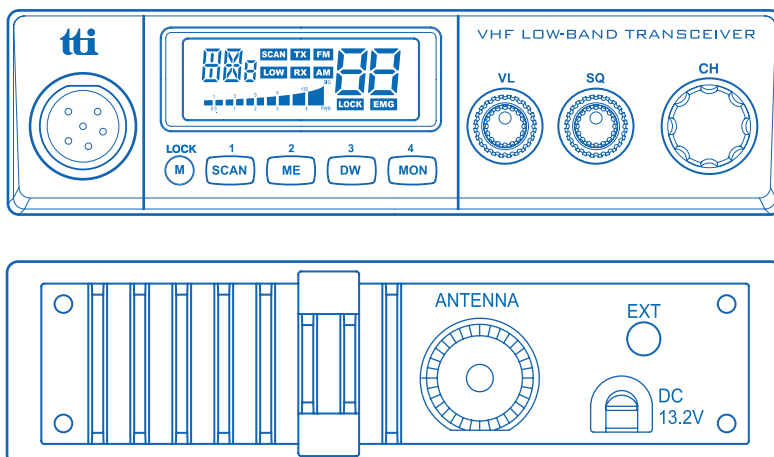

● TX-410 Features

- 41-48 MHz Band
- PC Programmable
- 12.5 KHz / 25 KHz Step
- Menu Mode
- 256 Channel Capacity
- CTCSS Tone Capability
- 4 Memory Channels
- 20 Watts Output Power
- Scan / Scan Memory
- 4 Memory Channels
- Keypad Lock
- Squelch Control
- Frequency Read-outs
- Monitor
- Dimension (W x H x L) : 140 x 37 x 230mm

TTI HANDS FREE SYSTEM

The Handsfree system for CB Radio and Land Mobile Radio offers the reliability of performance with refined cosmetic design. The microprocessor controlled functions are quite punctual and well operative. It goes well with any CB brands.

tti
TTI 2009



A good match with any CB !

THF-100 & THF-100P, along with its compact design controlled by the most updated micro-processor technology, enables you to enjoy easy and comfortable operation. Drive fun with TTI Handsfree !

Handsfree THF100/THF100P

● THF-100/THF-100P Features

- Electrically Controlled
- Handsfree On/Off
- Time Out Timer - 1,2,3, Minutes
- TX & RX LED
- Sensitive Microphone
- Long Enough Connection Wire
- Dimension (WxHxD) : 40 x 110 x 19.5 mm

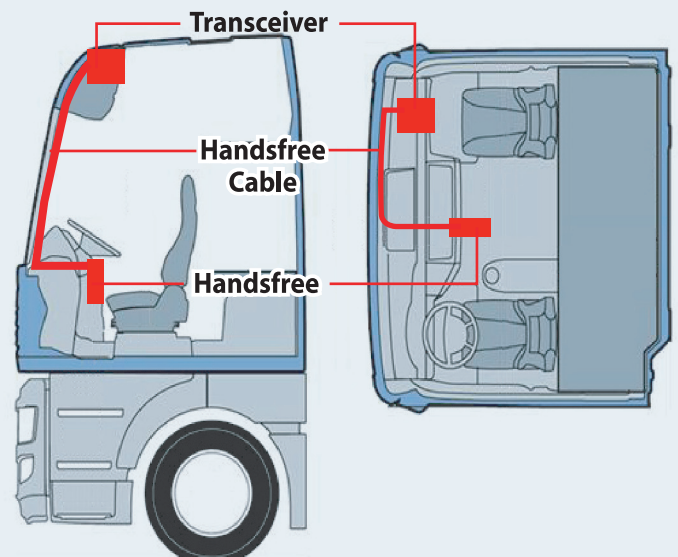

TTI CB ANTENNA SERIES

TTI supplies the most suitable antennas for TTI transceivers and also for other brands.

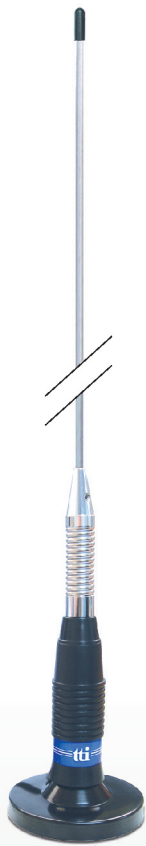

● CB-145

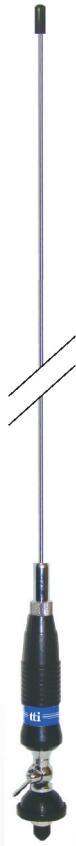

● CB-009



● CB-X14



● CB-024



● CB-030

CB Antennas

● Antenna Specifications

| MODEL | Freq. | Gain | Vsw1 | Power | Impedance | Connector | Cable | Length | Weight | Plug |
|--------|----------|------|-----------|-------|-----------|-----------|----------------|--------|--------|--------|
| CB-145 | 26-28MHz | 4 dB | < 1.1 : 1 | 500 W | 50 ohm | M | RG58U, 4meters | 153 cm | 230 g | PL 259 |
| CB-009 | 26-28MHz | 4 dB | < 1.1 : 1 | 500 W | 50 ohm | M | RG58U, 4meters | 160 cm | 300 g | PL 259 |
| CB-X14 | 26-28MHz | 4 dB | < 1.5 : 1 | 500 W | 50 ohm | M | RG58U, 4meters | 88 cm | 500 g | PL 259 |
| CB-024 | 26-28MHz | 4 dB | < 1.5 : 1 | 500 W | 50 ohm | M | RG58U, 4meters | 71 cm | 300 g | PL 259 |
| CB-030 | 26-28MHz | 4 dB | < 1.5 : 1 | 500 W | 50 ohm | M | RG58U, 4meters | 64 cm | 300 g | PL 259 |

● Magnet Specifications

| MODEL | Cable | Connector | Diameters | MODEL |
|---------|--------|-----------|-----------|--------|
| M-1303 | RG-58U | PL 259 | 140 mm | CB-145 |
| M-1307 | RG-58U | PL 259 | 115 mm | CB-X14 |
| CBM0924 | RG-58U | PL 259 | 89 mm | CB-024 |
| CBM-030 | RG-58U | PL 259 | 100 mm | CB-030 |

TTI EXTERNAL SPEAKER

TTI Supplies the most suitable external speakers for TTI transceivers and for other bands.

tti
TTI 2009



TTI-225

External Speakers

External Speaker Specifications

| | MODEL | Speaker | Power | V.C.IMP | Freq. | Size | Weight |
|---------|-------|---------|-------|---------|-------------|----------------|--------|
| TTI-6S | | 2 1/4 " | 5 W | 4/8 ohm | 600-4.5 KHz | 86 x 69 x 48 | 200 g |
| TTI-18S | | 2 1/4 " | 5 W | 4/8 ohm | 320-4.5 KHz | 83 x 54 x 76 | 200 g |
| TTI-20S | | 2 1/2 " | 5W | 4/8 ohm | 600-4 KHz | 105 x 105 x 55 | 175 g |
| TTI-21S | | 4 " | 5W | 4/8 ohm | 300-4.5 KHz | 450 x 22 x 80 | 390 g |
| TTI-22S | | 3.5 " | 6W | 4/8 ohm | 300-4.5 KHz | 130 x 55 x 70 | 320 g |
| TTI-23S | | 3 " | 6-8W | 5 ohm | 250-8 KHz | 110 x 40 x 95 | 306 g |

TTI DC-DC CONVERTER

TTI Supplies the most suitable DC-DC Converters for TTI transceivers and for other bands.

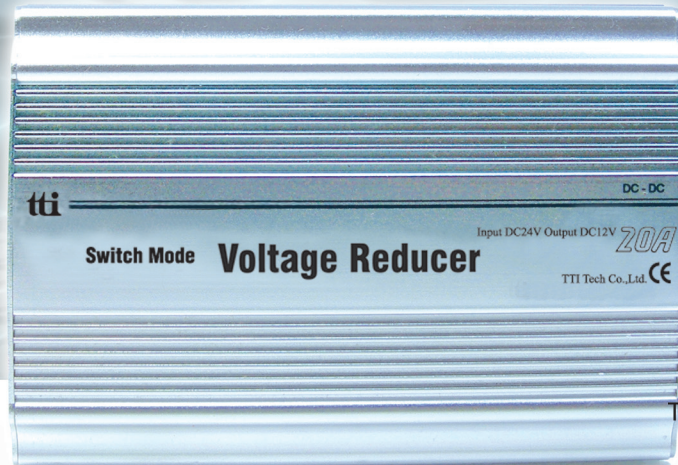

TDC-15A

DCDC-Converters

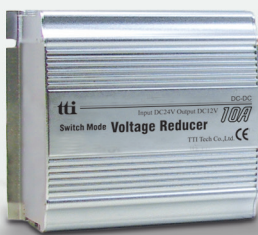

● TDC-10A

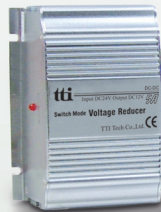

● TDC-5A

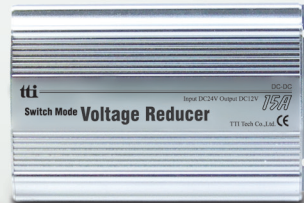

● TDC-15A

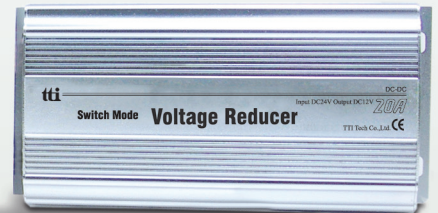

● TDC-20A

● DC-DC Converter Specifications

| MODEL | TDC-5A | TDC-10A | TDC-15A | TDC-20A |
|---------------------|--------------|---------------|---------------|---------------|
| Input Voltage | 18V-32V | 18V-32V | 18V-32V | 18V-32V |
| Output Voltage | 12V ± 5% | 12V ± 5% | 12V ± 5% | 12V ± 5% |
| Output Current | 5 A | 10 A | 15 A | 20 A |
| Max. Efficiency | > 90% | > 90% | > 90% | > 90% |
| Voltage Ripple | < 120mV | < 120mV | < 120mV | < 120mV |
| Voltage Stop | 14V ± 0.5V | 14V ± 0.5V | 14V ± 0.5V | 14V ± 0.5V |
| Protect Temperature | 50°C ± 20% | 50°C ± 20% | 50°C ± 20% | 50°C ± 20% |
| Volume | 82 x 89 x 47 | 104 x 89 x 47 | 142 x 89 x 47 | 182 x 89 x 47 |
| Weight | 0.4 Kg | 0.5 Kg | 0.6 Kg | 0.8 Kg |

TTI CB DIN-PLATE SERIES

TTI supplies rigidly designed and durable DIN-PLATE for TTI transceivers and also for other brands.

tti
TTI 2009

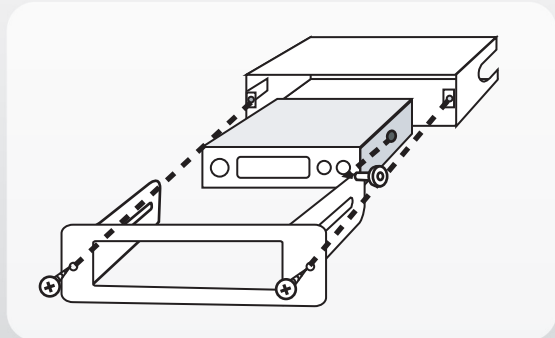

Din-Plates

• Din-Plate Dimensions

| | DIMENSION | | CB MODEL |
|----------|-----------|--|--|
| TDP-3000 | | | Din-Plate for TCB-880/881 |
| TDP-2000 | | | Din-Plate for TCB-660/770/770H/771/775 |
| TDP-1000 | | | Din-Plate for TCB-550 |

CB FEATURE TABLE

TTI CB FEATURE TABLE

| Model List Up | TCB-550 | TCB-660 | TCB-771 | TCB-881 | TCB-775 | TCB-880H | TCB-1100 | TX-410 | REMARK |
|------------------------|---------------|--------------|---------------|--------------|---------------|---------------|---------------|----------|--|
| Multi Band | x | x | x | x | x | x | x | 256 Chs. | |
| Output Power | 4W | 4W | 4W | 4W | 10W/4W | 25W/4W | 10W/4W | 20 W | |
| LCD Display | x | x | x | x | x | x | x | x | |
| MIC. Jack | x | x | x | x | x | x | x | x | |
| Microphone | x | x | x | x | x | x | x | x | |
| On/Off, Volume Control | x | x | x | x | x | x | x | x | |
| Squelch Control | Auto & Manual | Manual | Manual | Manual | Manual | Manual | Auto & Manual | Manual | |
| Channel 9/19 | x | x | x | x | x | x | x | - | |
| AM/FM | x | x | x | x | x | x | x | - | |
| Scan | x | x | x | x | x | x | x | x | |
| Band Selection | x | x | x | x | x | x | x | - | |
| Antenna Jack | x | x | x | x | x | x | x | x | |
| Ext. Audio Jack | x | x | x | x | x | x | x | x | |
| Back Lighting | x | x | x | x | x | x | x | x | |
| 12V/24V | 12V/24V | 12V | 12V-24V | 12V-24V | 12V | 12V | 12V/24V | 12V | |
| Speaker Location | Down | Down | Down | Down | Down | Down | Front | Down | |
| Menu Mode | x | x | x | x | x | x | x | x | Scan Delay Time / Back Light / Dimmer & Others |
| Microphone keys | - | Up/Down/Lock | Up/Down/Lock | Up/Down/Lock | Up/Down/Lock | Up/Down/Lock | Up/Down/Lock | - | |
| RF Gain Control | - | - | - | - | - | x | - | - | |
| MIC Gain Control | - | - | - | - | - | x | - | - | |
| Quick Up/Down | - | - | Rubber Button | 80 | Rubber Button | Rotary Switch | Rubber Button | - | |
| LCR | - | - | x | x | x | x | x | - | |
| S-Meter Jack | - | - | x | x | x | x | x | - | |
| Channel Memory | - | - | - | x | - | x | x | x | |
| Dual Watch | - | - | - | x | - | x | x | x | |
| PA Jack | - | - | - | x | - | x | x | - | |
| CB/PA Selector | - | - | - | x | - | x | - | - | |
| ANL/Off Selector | - | - | - | x | - | x | - | - | |
| Local/DX Selector | - | - | - | x | - | x | - | - | |
| Tone Channel | - | - | - | - | - | - | x | x | 38 CTCSS |
| VOX | - | - | - | - | - | - | x | - | |
| Frequency Readsouts | - | - | - | - | - | - | - | x | |
| Channel Spacing | - | - | - | - | - | - | - | x | 12.5/25KHz |
| PC Programmable | - | - | - | - | - | - | - | x | |

TTI PMR 446 RADIO SERIES

TTI PMR 446 Radio series always offers differences in design, quality and performance. This is already market proven by years of customer interface and feedback.

PMR-121TX

Compact But Versatile

The new PMR-121TX with its compact elegant design but full features like CTCSS, VOX, SCAN, and many others, is truly affordable PMR-446 radio in the world. In addition, it has excellent quality touch to satisfy the consumer radio users for many years.

Menu Driven feature selection makes PMR-121TX very user friendly and allows the users to quickly set up their choices of functions.

PMR-121TX Features

- 8 Channels
- 38 CTCSS
- VOX Mode
- Scan
- Battery Status Indicator
- Call Ringer (3 kinds)
- Roger Beep Tone On/Off
- Button Beep (Keytone) On/Off
- Keypad Lock
- LCD Back Lighting
- Fixed Antenna
- External Speaker, MIC, Chg. Jack
- Desk Top Charger : Dual

Compact Giant



ACCESSORIES



<TCG-1008>
Dual Charger Cradle



<TCG-1001S>
Power Adaptor



<AES-4211S/P>
Earset



<TBP-1006>
Battery AAA x 3

TTI PMR 446 RADIO SERIES

TTI PMR 446 Radio series always offers differences in design, quality and performance. This is already market proven by years of customer interface and feedback.

PMR-506TX

INTERCOM for Motorbikes



PMR-506TX with its aluminum metal cabinet and frame has excellent pocket-sized, but full-featured design in this slim and sleek shape.

A great range of radio features are supplemented with an internal Li-ion battery, able to deliver more than 8 hours operation in normal condition. Also, it comes with a twin unit intelligent charger.

PMR-506TX Features

- 500 mW
- 8 Channels
- 38 CTCSS
- Intercom
- VOX on/off
- Beep Tone
- Call
- Scan
- Monitor
- Room Monitor
- Smart Charger

ACCESSORIES



<AES-4211 TRS/TTRS>
Earset



<TCG-1001>
Power Adaptor

TTI PMR 446 RADIO SERIES

TTI PMR 446 Radio series always offers differences in design, quality and performance. This is already market proven by years of customer interface and feedback.

TXL-446PM



**PC
Programmable**

● PC Programmable Capacity

The new TXL-446 is the ideal for both commercial and consumer use with its PC programmable capability of channels as you may need various different requirement of usage.

● Long Battery Life

High capacity AAx3 NiMH battery can deliver more than 15 hours operation between chargers. Quick charging(4-5 hours) is available.

● Smart Charging System

Each radio is supplied with an intelligent desktop charger.

● Flexible Rubber Antenna

Soft and flexible antenna with high quality elements offers easy-carry.

● TXL-446 Features

- PC Programmable
- 28 Channels (8 Fixed + 20 Programmable)
- 38 CTCSS + 104 DCS
- More than 15 Hour's Battery Life
- Rotary Volume Switch
- Scan
- VOX
- Call
- Monitor

● ACCESSORIES



<AES-4212TTRS>
Earbud



<AMC-3010R>
Speaker Microphone



<TCG-1007SQ>
Charging Cradle



<TCG-1007SM>
Power Adaptor

TTI PMR 446 RADIO SERIES

TTI PMR 446 Radio series always offers differences in design, quality and performance. This is already market proven by years of customer interface and feedback.

TX-1446P

TTI 2009

IP 54

The new TX-1446P is the ideal for reliable communications in the toughest environment with its proven IP54 structures.

Menu Driven System as well as PC Programming

Easy to operate and highly adaptable, through the use of a menu driven configuration system as well as pc programmable function.

Smart Charging System

Each radio is supplied with an intelligent desktop charger. (Semi Quick Charger)

Compact, Handy Design, but Rugged

No other compact commercial PMR446 Radio can deliver so much versatility and functionality in this compact and handy size. This it also rugged and meeting military standard.

TX-1446P Features

- PC Programmable
- 8 Channels
- 50 CTCSS + 104 DCS
- More than 16 Hour's Battery Life
- Li-ion Battery (1000mAh)
- Rotary Volume Switch
- Rugged, Impact-Resistant Construction
- IP54 Water Resistant
- Semi-Quick Charger (4~5 hours)
- MIL-Standard 810,C,D,E&F

IP54 & PC Programmable



ACCESSORIES



<AES-4212TTRS>
Earbud



<AMC-3010R>
Speaker Microphone



<TCG-1006SQ>
Charging Cradle



<ACG-3312L>
Car Adaptor

TTI LPD RADIO SERIES

LPD is another field of TTI's interest. Even these are similar to PMR-446 radios, LPD radios need efficient power control technology leads TTI LPD radios to the top class in this category.

WP1/WP1 Trio

• Tourist Radio

This is what tourists need, what guide needs. Tourist never miss their team and groups. Guides never worry about careless followers, who might go astray. No more shout !

• WP1 / WP1 Trio Features

- Long Battery Life (More than 30 hours)
- Optional Multi Charger System
- Group Indication Channel
- High Visibility Display
- Multiple ISM Bands



PMR WPI



WPI TRIO

• ACCESSORIES



<TBP-1007>
Battery (AA x 3)



<AES-4213>
Earphone



<AES-5015/T>
Carrying Case



<TSC-WP1/Trio>
Suitcase Multi Charger

TTI LPD RADIO SERIES

LPD is another field of TTI's interest. Even these are similar to PMR-446 radios, LPD radios need efficient power control technology to manage the output power better.

TTI's experience proven technology leads TTI LPD radios to the top class in this category.

LPD-200

● Loud & Long Lasting

LPD-200TX loud speaker works clearly in any environmental that needs loud audio sound such as shopping malls, clubs and any open fields.

The 4.8V battery power system guarantees constant full output power and long lasting time between recharging.

● LPD-200 Features

- 2 W
- 69 Channels
- 38 CTCSS
- VOX on/off
- Beep Tone
- Roger Beep
- Call
- Scan
- Monitor
- Desktop Charger

Accessory Fully Equipped



● ACCESSORIES



<AES-4211TTRS>
Earbud



<TBP-1001>
Battery (AAA x4)



<TCG-1003S/T>
Single & Dual Charging Cradle



<TCGA-1001>
Power Adaptor

TTI LPD RADIO SERIES

LPD is another field of TTI's interest. Even these are similar to PMR-446 radios, LPD radios need efficient power control technology to manage the output power better. TTI's experience proven technology leads TTI LPD radios to the top class in this category.

LPD-400



Quick Charging System

Constant use of high power mode definitely requires ability to quickly re-charge the radio.

TTI's MCU controlled Smart & Quick charging system enhances the battery charging efficiency as well as battery life time itself.

LPD-400 Features

- 4W
- Compass
- Replaceable Antenna
- 69 Channel
- 38 CTCSS
- VOX on/off
- Beep Tone
- Call
- Scan
- Monitor
- Desktop Charger (Semi-Quick)



ACCESSORIES



<TBP-1004/1004T>
Charging Cradle



<ACE-5020>
Carrying Case



<AES-4211TTRS>
Earset



<TCGA-1004SM>
Power Adaptor



<ACG-3311H>
Car Adaptor

TTI LPD RADIO SERIES

LPD is another field of TTI's interest. Even these are similar to PMR-446 radios, LPD radios need efficient power control technology to manage the output power better. TTI's experience proven technology leads TTI LPD radios to the top class in this category.

LPD-500



Maximum Power Operation

This radio support the maximum power of full 5W and keep the constant power without power drop. This is the best choice for wild outdoor environment.

LPD-500 Features

- 5W
- Replaceable Antenna
- 69 Channel
- 38 CTCSS
- VOX on/off
- Beep Tone
- Call
- Scan
- Monitor
- Desktop Charger (Semi-Quick)



ACCESSORIES

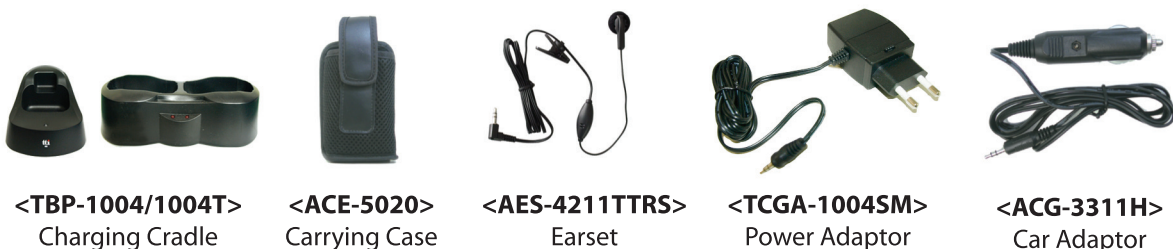

<TBP-1004/1004T>
Charging Cradle

<ACE-5020>
Carrying Case

<AES-4211TTRS>
Earset

<TCGA-1004SM>
Power Adaptor

<ACG-3311H>
Car Adaptor

TTI WIDEBAND RECEIVER

TTI's Receivers are capable enough to surprise expert as well as ordinary users, equipped with easy accessible keypad layouts, powerful memory and recall system.

TSC-3000R

Totally
Versatile



Capacity expandable bank system support variety of customer needs. Harmonized automatic and manual setting combination facilities its operation. Compact size associated with the light weight and high capacity Li-ion battery pack makes possible the whole day outdoor activity.

TSC-3000R Features

- Wideband up to 1,309MHz from 150KHz
- 1300 Memory Units
- 40 Expandable Manual Memory Banks
- 2 Automatic Memory Banks
- 1 Limited Search Memory Bank
- 1 Dual Watch Bank
- Well Defined Menu System in VFO Mode and in Memory Mode
- Cloning Function
- High Quality Audio Sound with 32 steps of Volume Adjustment
- Desktop Charger
- High Capacity(1900mAh) Li-ion Battery Pack

ACCESSORIES



<TAN-1040>
Antenna



<AES3220>
Earphone



<TCG-1006L>
Charging Cradle



<TBP-1194L>
Battery Pack

TTI NEW RECEIVER

TTI's Receiver are capable enough to surprise expert as well as ordinary users, equipped with easy accessible keypad layouts, powerful memory and recall system.

TSC-100R

Focused on Air band, VHF band, Low band(66-88MHz) and WFM Broadcast band, this narrow band receiver prides itself of exceptionally high sensitivity combined with harmonious audio sound. Simplified function adds to its convenience of use. Clear vision of buttons and large LCD helps the Operation. Inter-changeable use of rechargeable batteries and dry cells enhances the mobility.

● TSC-100R Features

- 66-88MHz, 88-108MHz, 108-136MHz, and 138-174MHz
- Bluetooth Operation (optional) Accessories
- 10 Memory Banks
- 200 Channel Memories
- Cloning
- Various Frequency Steps
- Desktop Charger (Optional)
- Replaceable Antenna
- High Quality Loud Speaker

● ACCESSORIES



<TAN-1042>
Antenna



<AES3220>
Earphone



<TCG-1007F>
Charging Cradle

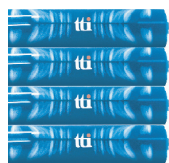

<TBP-1001>
Battery Pack



TTI MARINE RADIO

This model is most simplified but highlights indispensable features that offer user convenient environment. The performance is also maximized.

TX-150M

TTI's new radio emphasizes on the extra big sized super-bright LCD. Combined with translucent backlighting buttons arrayed in the center, the radio prides itself on its splendid appearance in combination of green, white and black colors. Super flexibility of the antenna adds the convenience as well as the safety enhancement. Despite water-proof nature and ruggedness, this radio never loses in design and compactness combining TTI's up-to-date technology and high capacity Li-ion Battery.

● TX-150M Features

- Waterproof (IP54)
- Power High / Low (4W/1W)
- Super-Bright Green Backlight LCD
- Auto Squelch
- Scan Function
- Direct Access to CH16
- Dual Watch
- Triple Watch
- Priority CH Scan
- Key Lock
- USA/INT'L/CANADA CH
- WX Alert (USA/CANADA)
- Loud Speaker
- External Standard Two Pin Jack
- Super Flexible and Replaceable Antenna
- Li-ion Battery Pack

*Extra Channels
for Each Country*



● ACCESSORIES



<TCGA-1007SM>
Power Adaptor



<AMC-3010RS>
Speaker Microphone



<TCG-1006SQ>
Charging Cradle



<TBP-1107L>
Battery Pack

TTI

Hand-Held RADIO

TTI makes difference Brings world together

www.ttikorea.co.kr



PMR-446 Radio

"TXL-446PM"

Long Battery Life & PC Programmable



Marine Radio

"TX-150"

Extra Channels For Each Country



PMR-446 Radio

"TX-I446P"

IP54 & PC Programmable



Wide-Band Scanner

"TSC-3000R"

Totally Versatile



PMR-446 Radio

"PMR-I2ITX"

Compact Giant



PMR/LPD FEATURE TABLE

PMR/LPD FEATURE TABLE



| Model Line Up | | PMR-121TX | PMR-506TX | TXL-446PM | TX-1446P |
|---------------------------------|--------|-------------------|-------------------|---------------------|--------------------|
| Frequency | | 446MHz | 446MHz | 433/446 MHz | 433/446 MHz |
| Channel | | 8 | 8 | 8 / 69 | 128 |
| Output Power | | 500mW | 500mW | 500mW / 2W | 4V / 500mW |
| Battery | | AAA x 3 | Li-ion | Li-ion | Li-ion |
| Dimensions (HxWxD) | | 84 x 49 x 28.3 mm | 88 x 54 x 14.8 mm | 109 x 56 x 30 mm | 98 x 63 x 31 mm |
| Battery Life (Hours, 5:5:90) | Ni-MH | 9 | - | 13 | - |
| | Li-ion | - | 10 | - | 8 |
| CTCSS | | 38 | 38 | 38 | 38 / 50 |
| DCS | | - | - | 104 | 88 / 104 |
| Roger Beep (on/off available) | | x | x | x | x |
| Antenna | | Fixed | Fixed | Fixed / Replaceable | Replaceable |
| Power High / Low | | - | - | x | x |
| Scan | | x | x | x | x |
| Dual Watch | | - | - | x | x |
| Triple Watch | | - | - | - | - |
| Monitor Key | | - | x | x | x |
| LCD Backlighting | | x | x | x | x |
| Built-in speaker | | x | x | x | x |
| Power on/off | | Electrical | Electrical | Rotary Knob | Rotary Knob |
| Volume Up/ Down | | x | x | Rotary Knob | Rotary Knob |
| CALL Sound | | 3 kinds | 3 kinds | 5 kinds | 5 kinds |
| VOX | | 1 step | 2 steps | 3 Steps | 5 Steps |
| Intercom | | - | x | - | - |
| Squelch Adjustment | | - | - | x | x |
| Key Tone (fixed always on) | | On / Off | On / Off | On / Off | On / Off |
| Key Lock | | x | x | x | x |
| External Charging | | Twin Charger | Twin Charger | Semi Quick Charger | Semi Quick Charger |
| Auto Power Save | | x | x | x | x |
| SPK/MIC Jack | | 2.5 phi | 3.5 phi | 2 pin Standard | 2 pin Standard |
| Cloning | | - | - | - | x |
| PC Programmable | | - | - | x | x |
| Extra Channel Selection | | - | - | - | - |

PMR/LPD FEATURE TABLE

PMR/LPD FEATURE TABLE



| WP1 & WP1TRIO | LPD-200 | LPD-400 | LPD-500 | TX-150M |
|-----------------------|-------------------|------------------|------------------|--------------------|
| 470MHz / More | 433MHz | 433MHz | 433MHz | VHF Marine |
| 80 / More | 69 | 69 | 69 | 55 |
| 100mW / 100mW | 2 W | 4 W | 5 W | 4 W |
| AA x 3 | AAA x 4 | AAA x 5 | AAA x 5 | Li-ion |
| 81 x 49.8 x 33 mm | 93 x 57 x 28.4 mm | 101 x 60 x 29 mm | 101 x 60 x 29 mm | 112 x 62.5 x 30 mm |
| 30 | 9 | 8 | 8 | - |
| x | - | - | - | 8 |
| x | 38 | 38 | 38 | - |
| x | - | - | - | - |
| x | x | x | x | x |
| Fixed | Fixed | Replaceable | Replaceable | Replaceable |
| - | x | x | x | x |
| - | x | x | x | x |
| - | - | x | x | x |
| - | - | - | - | x |
| - | x | x | x | x |
| x | x | x | x | x |
| x | x | x | x | x |
| Electrical | Electrical | Electrical | Electrical | Rotary Knob |
| x | x | x | x | Rotary Knob |
| - | 1 Fixed | 5 Kinds | 10 Kinds | - |
| - | 1 Step | 3 Steps | 3 Steps | - |
| - | - | - | - | - |
| - | - | x | x | x |
| - | x | On / Off | On / Off | On / Off |
| x | - | x | x | x |
| Wall/Suitcase Charger | Twin Charger | Twin Charger | Twin Charger | Semi Quick Charger |
| x | x | x | x | x |
| 3.5 phi | 3.5 phi | 3.5 phi | 3.5 phi | 2 Pin Standard |
| - | - | - | - | - |
| Dependent on versions | - | - | - | x |
| - | - | - | - | x |

PMR/LPD ACCESSORY LIST

| | PMR-121TX | PMR-506TX | TXL-446PM | TX-1446P | WP1 & WP1TRIO |
|-------------------------------|---|--|--|---|---|
| Earset |  AES-4211/4211SP |  AES-4211/4211TRS/4211TTRS |  AES-4212TRS / 4212TTRS |  AES-4212TRS / 4212TTRS |  AES-4213 / AMC-3012(MIC) |
| Speaker Microphone | X | X |  AMC-3010R |  AMC-3010R | X |
| Car Adaptor |  ACG-3311S / 3311SP |  ACG-3311 |  ACG-3313L |  ACG-3312L | X |
| Charger Cradle |  TCG-1008 |  TCG-1012 |  TCG-1007SQ / 1007DSQ |  TCG-1006SQ |  TSC-WP1/TRIO (Suitcase Charger) |
| Power Adaptor |  TCGA-1001TS / 1001S |  TCGA-1001 |  TCG-1007SM |  TCG-1007SM |  TCGA-1001SM |
| Battery |  TBP-1006 (AAA x 3) |  TBP-1004 |  TBP-1007 (AA x3) |  TBP-1107L |  TBP-1007 (AA x3) |
| Antenna | X | X |  TAN-1090 |  TAN-1060 | X |
| Beltclip |  TBC-1003 | X |  TBC-1007 |  TBC-1006/1006S | X |
| Carrying Case |  ACE-5017 |  ACE-5016TR |  ACE-5021 |  ACE-5018 |  ACE-5015 |
| Aqua Pack |  AQA-5000 |  AQA-5000 |  AQA-5018 |  AQA-5018 | X |
| Cloning Cable | X | X | X |  TCC-1000 | X |
| PC Program Cable | X | X |  TPC-5000 |  TPC-5000 | X |

PMR/LPD RADIOS ACCESSORIES

PMR/LPD ACCESSORY LIST

| LPD-200 | LPD-400 | LPD-500 | TSC-3000R | TSC-100R | TX-150M |
|---|--|--|--|---|---|
|  AES-4211/4211TRS/4211TTRS |  AES-4211/4211TRS/4211TTRS |  AES-4211/4211TRS/4211TTRS |  AES-3220 |  AES-3220 |  AES-4212TRS/4212TTRS |
| X | X | X | X | X |  AMC-3010R |
|  ACG-3311 |  ACG-3311H |  ACG-3311H |  ACG-3312L |  ACG-3311 |  ACG-3312L |
|  TCG-1003S / TCG-1003T |  TCG-1004 / 1004T | |  TCG-1006L |  TCG-1007F |  TCG-1006SQ |
|  TCGA-1001 |  TCG-1004SM |  TCG-1004SM |  TCG-1007SM |  TCG-1007SM |  TCG-1007SM |
|  TBP-1001 (AAA x 4) |  TBP-1107 (AAA x 5) |  TBP-1107 (AAA x 5) |  TBP-1194L |  TBP-1006 (AAA x 3) |  TBP-1107L |
| X |  TAN-1050L |  TAN-1060L |  TAN-1040 |  TAN-1042 |  TAN-1070 |
|  TBC-1003 |  TBC-1005 |  TBC-1005 |  TBC-1006S |  TBC-1007 |  TBC-1006 / 1006S |
|  ACE-5017 |  ACE-5020 |  ACE-5020 |  ACE-5018 |  ACE-5021 |  ACE-5018W |
|  AQA-5000 |  AQA-5018 |  AQA-5018 |  AQA-5018 |  AQA-5018 |  AQA-5018 |
| X | X | X |  TCC-1000 |  TCC-1000 | X |
| X | X | X |  TPC-5040 |  TPC-5040 | X |

TTI 2009

